



TEN-4

SPEAKER KIT

MODEL NUMBER: IA-FR-SPKR-104-BK

Congratulations on the purchase of your IASUS Concepts TEN-4 Speaker Kit! You have now joined an increasing group of individuals enjoying IASUS communication solutions.

Please review this owner's manual before use and follow our recommended installation procedures to get your TEN-4 speaker kit performing at its absolute best. Should you have any questions and require assistance with setup and usage, please feel free to visit our website:

WWW.IASUS-CONCEPTS.COM

Or contact us directly at: **info@iasus-concepts.com**

ABOUT THIS MANUAL

We recommend reviewing this instruction manual in its entirety before using your TEN-4 speaker kit.

It introduces and explains the TEN-4's features, how to set it up, and correct operation for a rich user experience that you come to expect.

WARNINGS

Any changes or modifications to this product not expressly approved by IASUS Concepts Ltd. could void the 1-year limited warranty. Should there be any questions or concerns about modifications, please contact IASUS.

SPEAKER SPECIFICATIONS

 **DIMENSIONS**
98mm x 88mm x 40mm
4" x 3.5" x 1.5"

 **WEIGHT**
187g | 6.5oz

 **BATTERY**
OPERATION 15-20 HOURS /charge
CHARGING VOLTAGE DC 5V / 500mA
CHARGING TIME 3-5 HOURS
LITHIUM BATTERY 3.7V / 2200mAh
WORKING TEMP. -10°C / +45°C

 **AUDIO**
POWER OUTPUT 15W
OUTPUT IMPEDANCE 2Ω
S/N RATIO 100dB@32Ω, 20mW
FREQ RESPONSE 90Hz to 18000Hz

TABLE OF CONTENTS

PACKAGE CONTENTS	4
PARTS & CONTROLS REFERENCE.....	5
CONNECTING THE TEN-4 SPEAKER KIT	6
USING THE TEN-4 SPEAKER KIT	7
USE AND CARE OF THE GP3-R THROAT MIC.....	8
MAGNETIC BREAKAWAY CLASP.....	9
OPERATING THE TEN-4 SPEAKER	9
CONTROLS	9-10
LOW BATTERY	10
CHARGING THE TEN-4 SPEAKER	11
1-YEAR LIMITED WARRANTY	12

PACKAGE CONTENTS

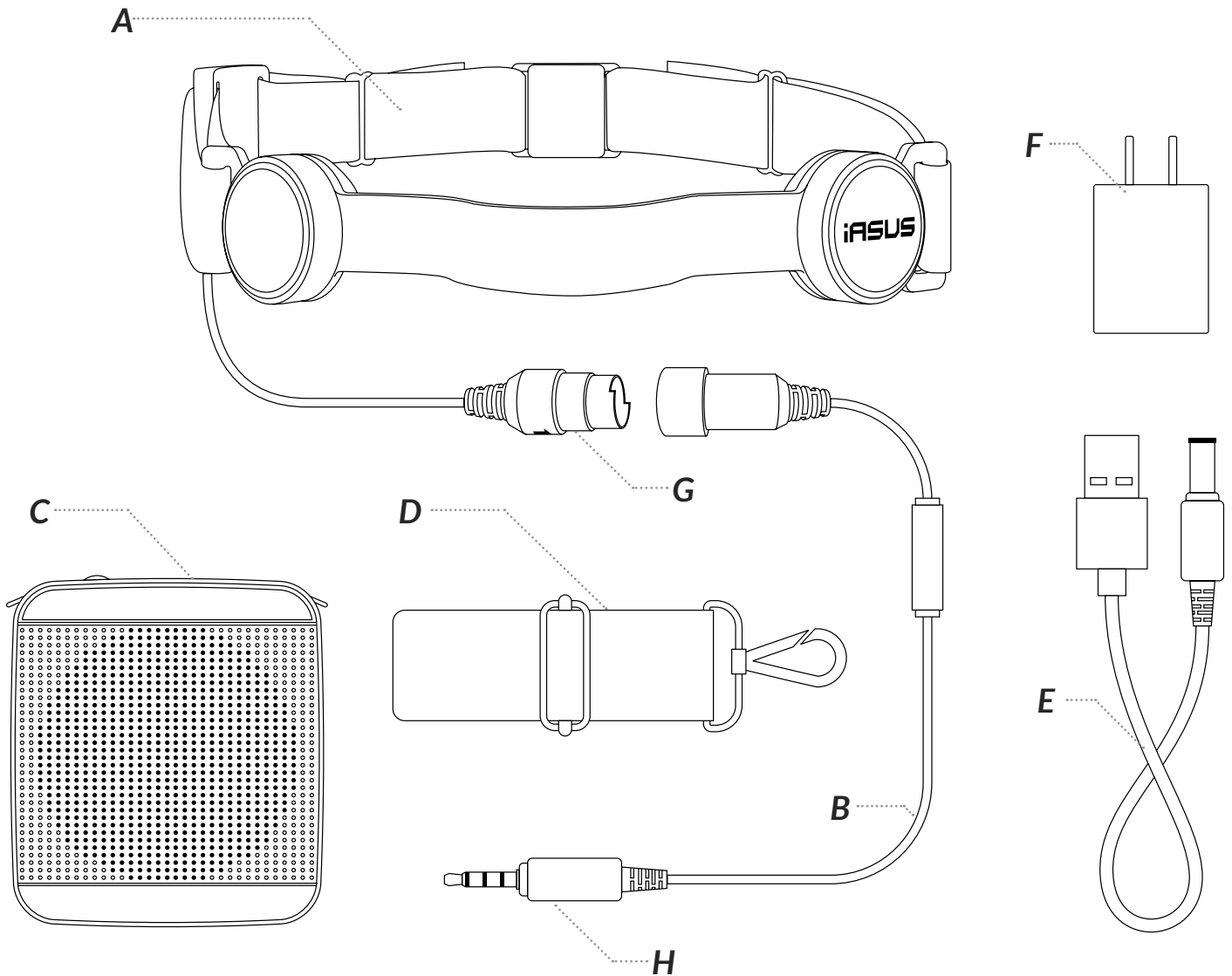

-
- A..... **GP3-R Throat Mic**
 - B..... **Throat Mic Adapter**
 - C..... **TEN-4 Speaker**
 - D..... **Shoulder Strap**
 - E..... **USB Charging Cable**
 - F..... **Power Adapter**
 - G..... **DIN Connector**
 - H..... **3.5mm Headphone Plug**

PARTS & CONTROLS REFERENCE

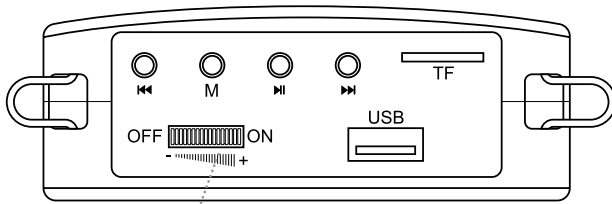

1

4

3

2

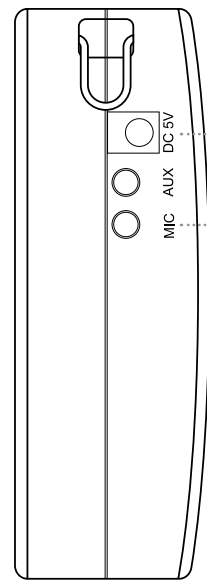
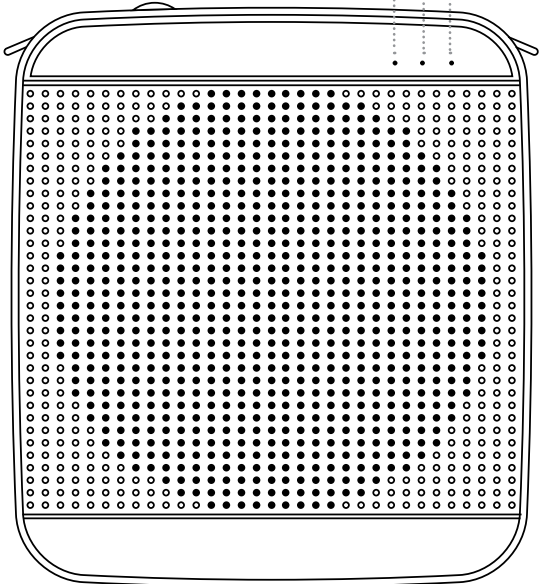

5

6

-
- 1 **Power ON/OFF | Volume Control**
 - 2 **Charging LED**
 - 3 **Power ON LED**
 - 3 **PA Mode LED**
 - 4 **DC 5V Charging Port**
 - 5 **Microphone Port**

CONNECTING THE TEN-4 SPEAKER KIT

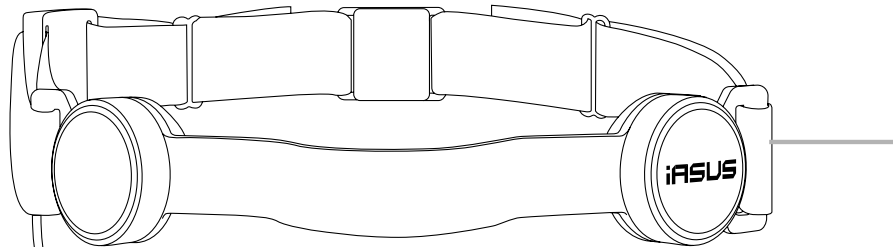

GP3-R
IASUS THROAT MIC

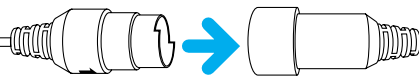

EXTENSION CABLE
DIN CONNECTOR TO 3.5MM
HEADPHONE PLUG

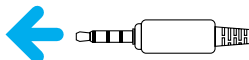
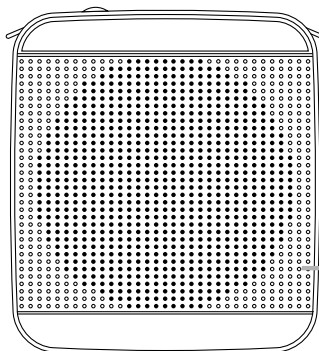

TEN-4 SPEAKER

USING THE TEN-4 SPEAKER KIT

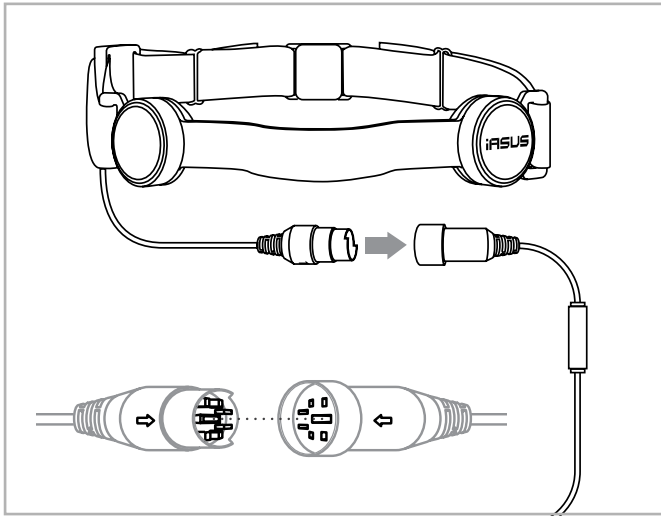

1. Plug the GP3-R throat mic (A) into the throat mic adapter (B) using the DIN connectors (G).

Be sure to align the arrow indicators before firmly pressing them together to avoid bending the pins.

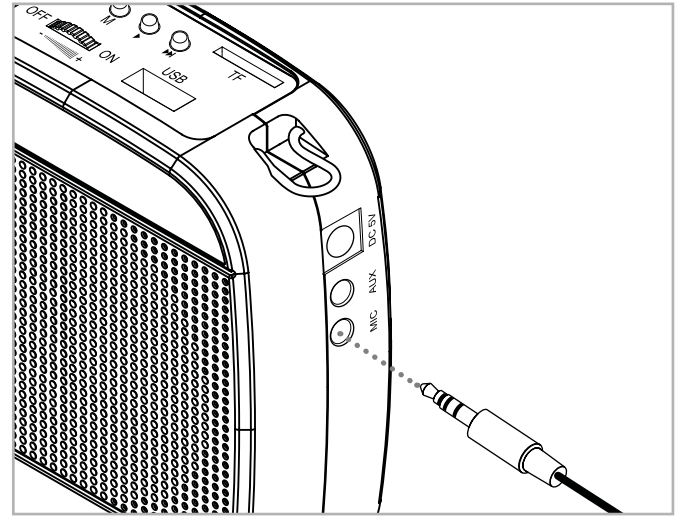

2. Plug the 3.5mm headphone connector (H) of the throat mic adapter into the Microphone Port (6) of the speaker.

Turn on the speaker *See Using the TEN-4 speaker section*

3. Wearing the throat mic:

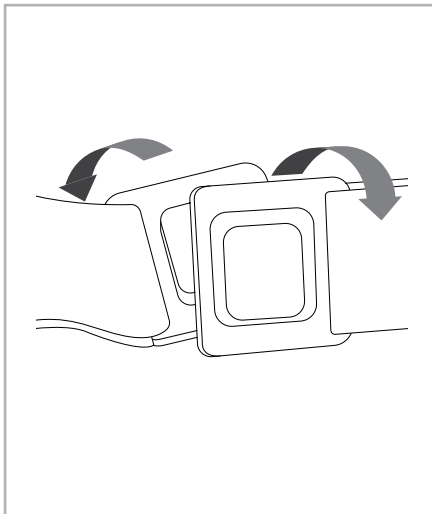

I. Open the magnetic breakway clasp by twisting them apart.

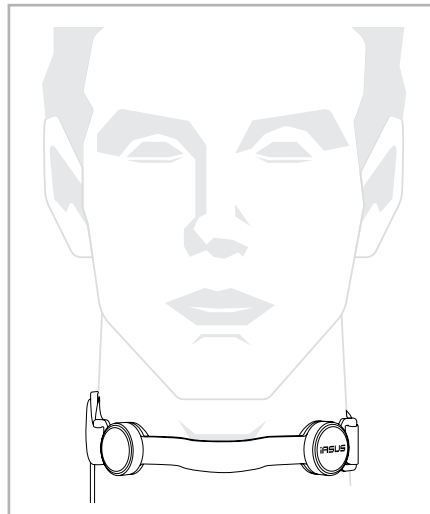

II. Place the throat mic around your neck and reapply the clasp so that it makes contact all around.

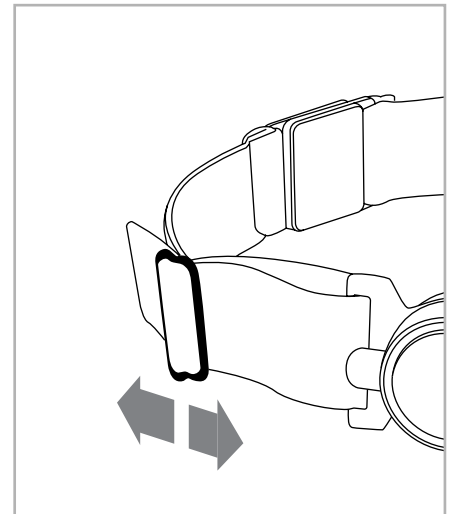

III. Adjust the neck strap for tightness by using the adjusters (E). The throat mic needs to be just snug but not tight around your neck.

TIP: Due to variances in neck shapes and sizes, adjusting and testing the position of the throat mic will be necessary to achieve optimal performance. Pay close attention to ensure the Gen 3.0 Transponder Microphone (A) makes good contact with your throat and level with where the larynx (voice box) is located.

USE AND CARE OF THE GP3-R THROAT MIC

WEARING THE THROAT MIC:

For the best transmission quality when using the GP3-R, place the Gen 3.0 Transponder Microphon (A) about 0.5 - 1 inch on either side of your larynx / voice box. The optimal transponder position on the neck will vary between individuals.

The GP3-R's neck strap is adjustable. To increase or decrease the diameter, length or shorten the neck strap by using the neck strap adjusters (E).

NOTE: The transponder should rest comfortably on the neck and be contacting your neck at all times - it should not be too tight. The adjustable strap is stretchable to offer flexibility in order for the throat mic to stay in position. Do not over tighten the straps.

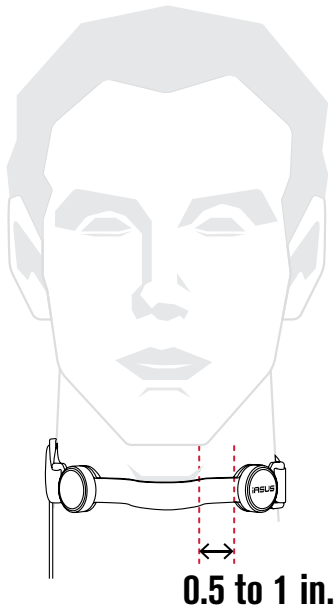

SPEAKING WITH THE THROAT MIC:

Speak in a calmly, clearly, and softly, as the Gen 3.0 Transponder microphone is very sensitive. Failing to do so will result in muffled and distorted audio on the receiving end. This is caused by the voice overpowering the microphone, and in turn, clipping the input audio.

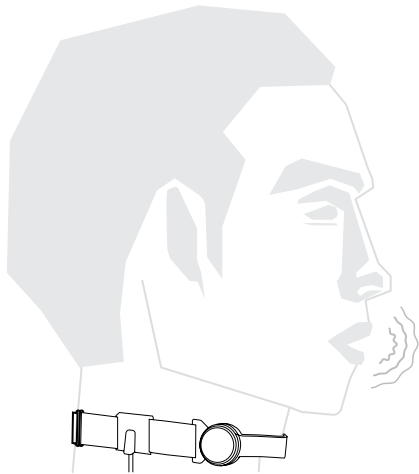

CLEANING THE THROAT MIC:

A soiled neck strap can be removed from the GP3-R and washed with mild soap and water, then hung dry. Do not submerge the GP3-R throat mic with the adjustable neck strap in water or put into a washing machine.

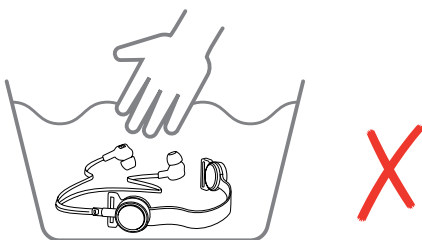
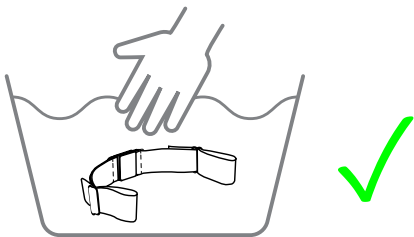

IMPORTANT: While the GP3-R is rated IP65 and protected from water splashes, it is not waterproof. Do not submerge the throat mic in water.

MAGNETIC BREAKAWAY CLASP

The GP3-R Throat Mic is equipped with a Magnetic Breakaway Clasp that speeds up putting it on and taking it off. As well, it allows for a quick disengagement in emergency situations.

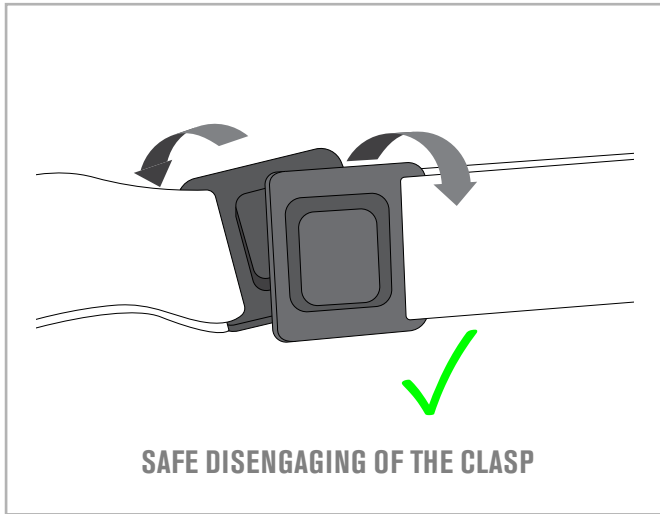

Under normal circumstances during regular use, use both hands to disengage the clasp by twisting them apart.

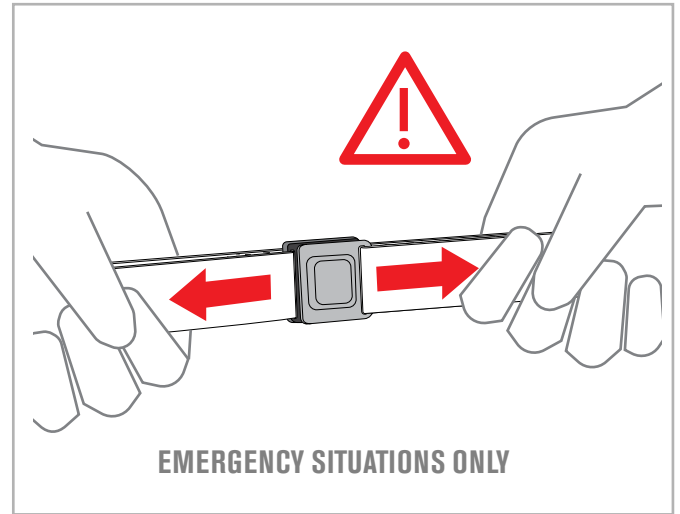

In the event of an emergency where removal of the GP3-R is required, pulling the neck strap apart in opposite directions will quickly disengage the clasp.

OPERATING THE TEN-4 SPEAKER

CONTROLS

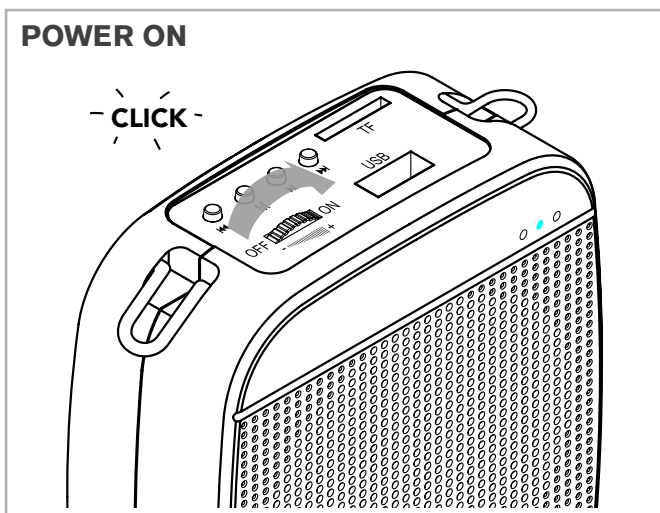

To power on the TEN-4 speaker and increase the volume, turn the volume control wheel (1) clockwise until you hear and feel a click. A blue light will indicate the speaker is turned on.

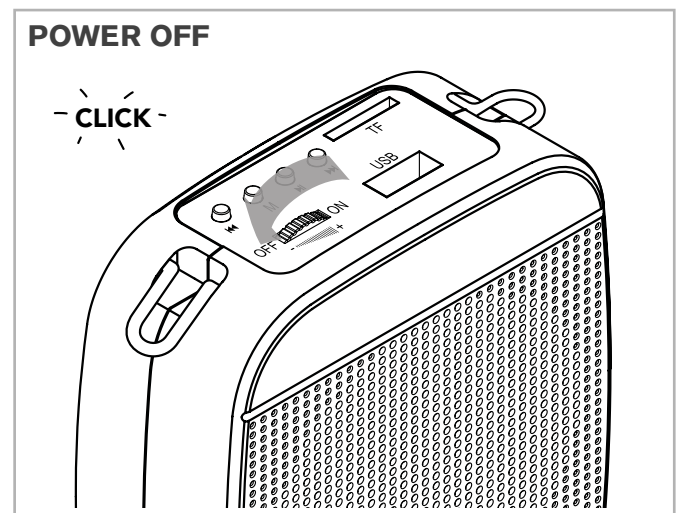

To power off the EAR3H, turn the volume control wheel (1) counter-clockwise until you hear and feel the click.

VOLUME UP

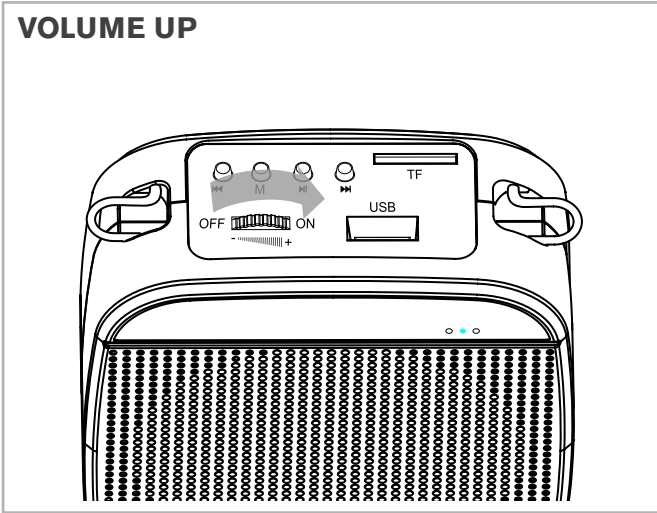

Power on the speaker and continue turning the volume control wheel clockwise, toward the **+** sign to your desired volume level.

VOLUME DOWN

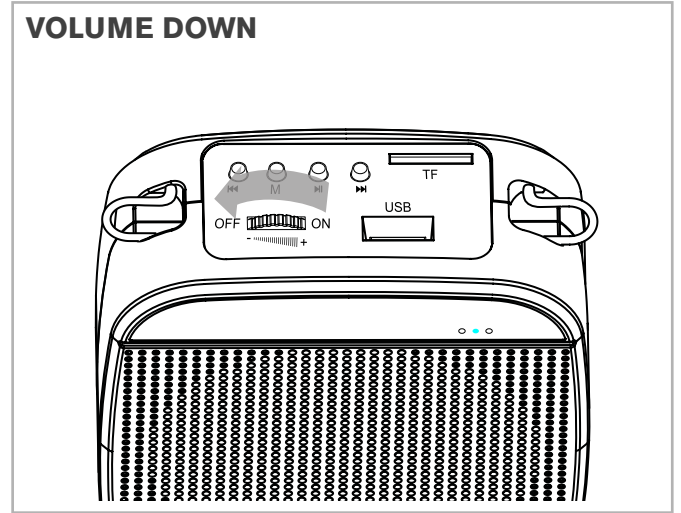

To decrease the volume, turn the volume control wheel counter-clockwise, toward the **-** sign to your desired volume level.

LOW BATTERY

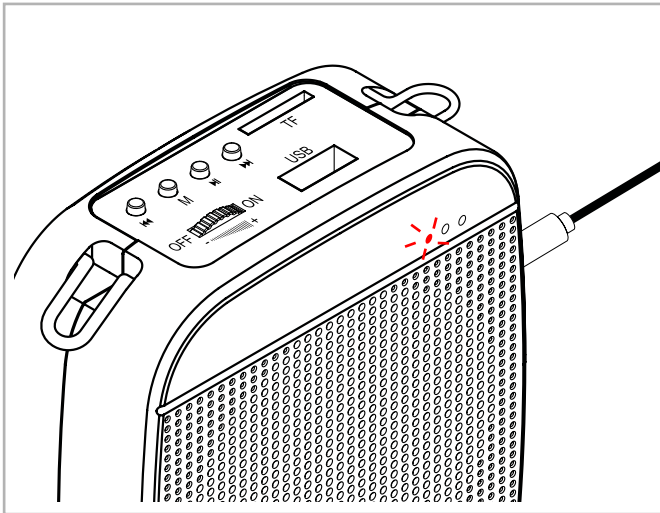

A flashing red light indicates that the device is low on battery.

CHARGING THE SPEAKER

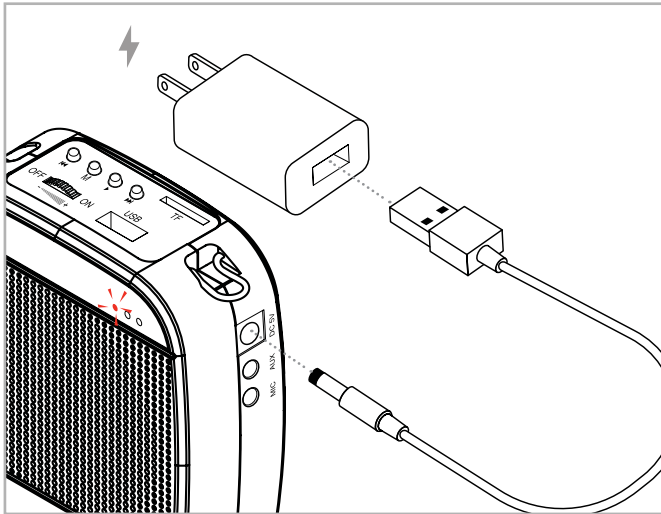

A red light indicates that the device is low on battery. Only use the provided power adapter (F) and charging cable (E) to charge the speaker.

First, Insert the charging cable in the DC 5V charging port of the speaker (5), then connect the USB plug to the Power Adapter (F).

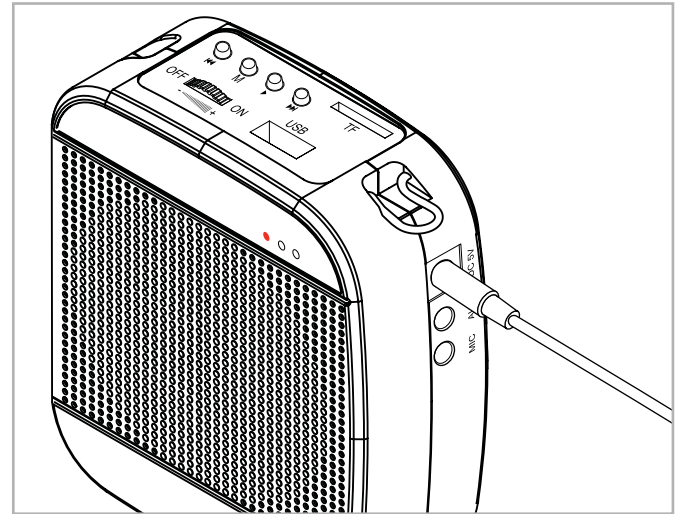

A full charge requires approximately 3-5 hours. Once the speaker is fully charged, the charging LED indicator becomes a solid red light.



WARNING:

- We do not recommend using the speaker while charging. If you need to use the speaker before a complete charging cycle, unplug the charging cable from the speaker before to operate the device.
- Do not operate the device and accessories close to an open fire.
- Do not immerse the device and accessories in water, or any other liquid, or fire
- Do not open the battery components of the speaker
- Do not operate the device in environments where wireless devices are prohibited
- Do not operate the device in highly flammable or combustible areas such as gas stations, flammable or chemical products, transportation and storage facilities
- Do not operate the device in an airplane

1-YEAR LIMITED WARRANTY

IASUS Concepts Limited warrants that the EAR3H Helmet Amp sold by IASUS Concepts or its authorized agents is free from defects in materials and workmanship under normal use for one year. This warranty is only applicable to the original purchaser in possession of a dated sales document receipt that includes the name and the company from which it was purchased. This warranty is in lieu of and excludes all other warranties, expressed or implied, including any implied warranty of merchantability or fitness, and of any other obligation on the part of IASUS Concepts Limited.

WHAT THIS WARRANTY DOES NOT COVER

- Damage from improper operation, misuse, neglect such as dropping the product onto hard surfaces, contact with extreme humidity or heat, or acts of nature (lightning, floods, power surges, etc.).
- Products that may have been tested, adjusted, installed, maintained, repaired or altered in any way by persons not expressly approved by IASUS Concepts Limited.
- Cords that are stretched, burnt, torn or cut.
- Products purchased more than 12 months previous to the current date.
- Products that are not accompanied by a valid proof of purchase.

TO REGISTER FOR YOUR WARRANTY

You must register your product to receive warranty service. To do so and to view detailed information about our warranty service, please visit :

<https://iasus-concepts.com/warranty/>

TO GET WARRANTY SERVICE FROM IASUS CONCEPTS

Please contact our customer service department via our website. Once you have done so, you will receive instructions on how to ship the products to IASUS Concepts or to one of our designated service centers. If instructed to ship the product, you must ship it with freight, duties and insurance prepaid. Regardless of where you are instructed to ship your product, you must include:

- A copy of your dated sales document receipt
- A fully completed Return Materials Authorization (RMA) form.
- Payment for any services or repairs not covered by the warranty. This will have been predetermined with your customer service representative.

LEGAL INFORMATION

There is no informal dispute settlement mechanism available. This warranty gives you specific legal rights, and you may also have other rights, which vary geographically. Some areas do not allow limitations on how long an implied warranty last and/or do not allow the exclusions or limitations or consequential damages. IF this is true for your area, the above limitations or exclusions may not apply to you. IASUS Concepts shall not be liable for any special or consequential damages or for loss or expense directly or indirectly arising from use of the product, inability to use the product in combination with other equipment, or from any other cause. IASUS Concepts reserves the right to make changes in the design of the product and to make additions or improvements to it without incurring any obligation to modify any products previously sold.

FOR LATEST NEWS AND PRODUCTS,
FOLLOW US ON SOCIAL MEDIA

 /iasus.concepts

 /zerobackgroundnoise